

TG GripSert Workholding Grippers

Intended Use

TG GripSert workholding grippers and jaws are suitable for clamping castings, unmachined parts and parallel-milled workpieces.

Safety Precautions

- TG GripSert grippers and jaws can be used with all TriMax Series vises. For all other clamping systems, please ensure compatibility with the TG GripSert grippers.
- Read the operating instructions before commencing any work.
- Clamping presents a danger to persons and surroundings.
- Clamp the workpiece securely. The workpiece will not be held safely if insufficient clamping force is supplied.
- Follow all accident prevention instructions applicable to your machine.
- Avoid all hazardous working practices.

Technical Features

Special features of TG GripSert workholding grippers:

1. TG GripSert triangular shape
 - Creates a coupling without any clearance.
 - Divides the clamping forces.
 - Absorbs vibrations, allowing high stability and secure workholding.
2. TG GripSert 5-degree taper
 - Creates a pull-down effect onto the gripper which is transferred to the workpiece and prevents lifting.
3. Special sharpened teeth (with a larger angle on lower portion of gripper than on upper portion)
 - Creates pull-down effect on the workpiece.
 - Permits clamping with a lower clamping force after the engraving, preventing excessive deformation of the workpiece.

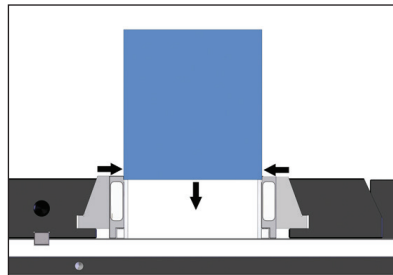

The combination of the tapered shape and teeth geometry of grippers creates a double pull-down effect on workpiece.

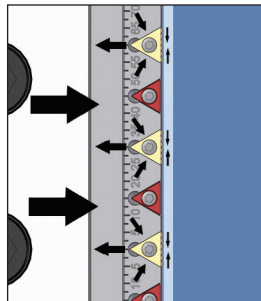

Application

1. Screw the TG GripSert jaws to the vise (TriMax, Kurt or other). Suggested clamping force = 30 ft-lb. For correct clamping, make sure to use the proper screw length for your specific vise. Proper length is determined by adding the thickness of the TG GripSert jaws and the depth of the thread of your own vise.

Example:

12 mm jaw thickness + 10 mm vise thread depth = 22 mm screw thread length needed.

2. Tighten the TG GripSert grippers at the jaw using the screws to 1.5 ft-lb with a TORX T9 screwdriver (F658-450310) or TORX T9 wrench (F658-450320). Make sure to place the grippers in parallel to the dovetail seat.

3. Select suitable clamping points on the workpiece. Make sure that the teeth of the gripper are positioned to penetrate the surface of the workpiece evenly. If the workpiece is irregular in shape, it is best to use a floating jaw.

Notes:

- Do not clamp in the vicinity of any mold joints or dressed areas.
- Grind flame cut contours with hard regions with an angle grind.
- Do not hit the workpiece with a hammer after the clamping. This may break the grippers.

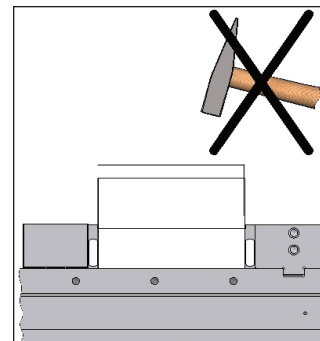
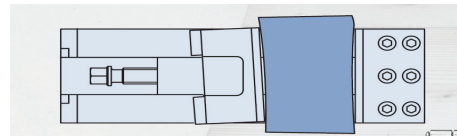

Use of Snap-in Parallels

Some TG GripSert jaws are designed for use with our exclusive Snap-in parallels, available in various heights and sold in pairs. The self-locking design of the parallels allows for the quick and easy installation on the TG GripSert jaws with no additional tools. This allows for reduced downtimes, the elimination of clamps and locks, and increased accuracy of the finished parts.

Used with Snap-in parallels, TG GripSert grippers can clamp workpiece surfaces from .080"-.200" (depending on the parallel height and the model of jaws).

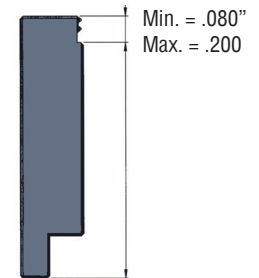

Protection of TG GripSert Pockets on Jaws

When TG GripSert grippers are not installed on your jaws, install the aluminum protective covers (TG-PRO) in the empty pockets to keep out dirt and debris.

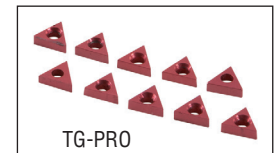

Fairlane Products

33792 Doreka Drive

Fraser MI 48026

Phone: 586-294-6100

Fax: 586-294-6822

www.fairlaneproducts.com

Penetration of the Grippers

The ratio between the number of TG GripSert grippers and penetration depth is inversely proportional (fewer grippers = more penetration). Charts below show the penetration depth of each TG GripSert gripper tooth into the workpiece in relation to the number of grippers used, the type of material and the clamping force.

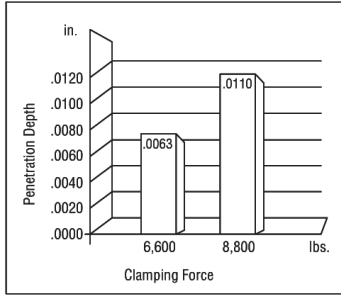

Material	Steel*
Grippers	5 per jaw (10 total)
Clamping Surface	.080"

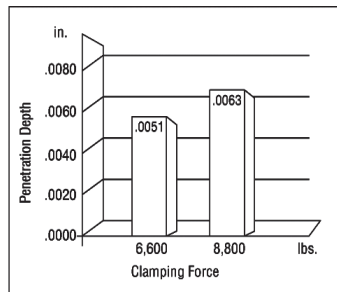

Material	Steel*
Grippers	5 per jaw (10 total)
Clamping Surface	.140"

* Steel with tensile strength = 980 N/mm2

** Hardened Steel / Titanium HRC 50-54

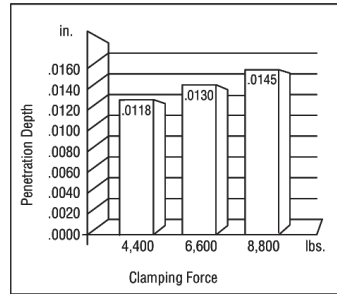

Material	Aluminum
Grippers	5 per jaw (10 total)
Clamping Surface	.140"

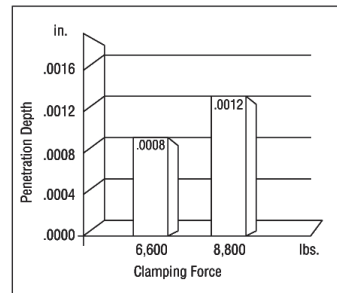

Material	Hardened Steel**
Grippers	5 per jaw (10 total)
Clamping Surface	.140"

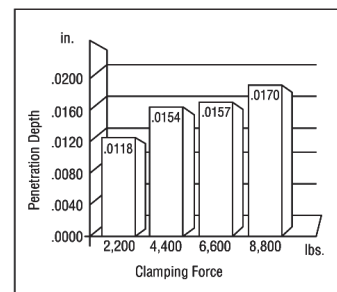

Material	Steel*
Grippers	1 per jaw (2 total)
Clamping Surface	.140"

Clamping Force in Relation to the Number of Grippers

With reference to the charts shown to the left, the suggested clamping forces are as follows:

Clamping Force Range 1-3 grippers per jaw (.140" clamping surface):

- for Aluminum (TG-ALU): Range of 2,200 lbs - 4,400 lbs
- for Steel (TG-STD): Range of 4,400 lbs - 6,600 lbs
- for Hardened Steel/Titanium HRC 50-54 (TG-HRC): Range of 6,600 lbs - 8,800 lbs

Clamping Force Range 4-7 grippers per jaw (.140" clamping surface):

- Aluminum (TG-ALU): 4,400 lbs - 8,800 lbs
- Steel (TG-STD): 6,600 lbs - 11,000 lbs
- Hardened Steel/Titanium HRC 50-54 (TG-HRC): 8,800 lbs - 11,000 lbs

Note: For a clamping surface of .08" on any above, reduce the clamping force by 30%.

Use of TG GripSert Grippers with Chuck Jaws

For the use of TG GripSert grippers with chuck jaws, observe all manual guidelines. The minimum diameter of the workpiece is 2".

Clamping Force and Workpiece Deformation

In situations where deformation of a workpiece is a concern, you can reduce the clamping force after the grippers penetrate the workpiece.

TG GripSert Pockets

If you are making your own jaws or clamping devices, use suitable material (steel Rm 800 N/mm2 or higher). Materials such as cast iron and aluminum are not recommended.

The seat of the gripper must be pre-machined and the finishing of the tapered seat (see drawing below) requires the use of the finishing cutting tool (TG-CUTTER, see photo).

Parameters of the 3.3 mm diameter cutting tool: V = 80%120 M/mm; Fz = .02 mm per tooth (the cutting tool is 3-fluted).

